



ANALYSIS OF THE INFLUENCE OF THE SYNCHRONOUS SUPPLY METHOD ON THE PERFORMANCE OF THE ASSEMBLY LINES

Ana Cornelia GAVRILUȚĂ

University of Pitesti, Romania

*Corresponding author e-mail: ana.gavrilita@upit.ro

Article history

Received 06.08.2022

Accepted 10.10.2022

DOI <https://doi.org/10.26825/bup.ar.2022.003>

Abstract. Today, businesses must deal with very demanding customers and fierce competition. To be able to face all these demands, they must have a competitive production system. Until now, research has focused on methods to improve production, but today companies are beginning to realize that an improvement in internal logistics is equally an alternative to attract a new advantage on their side. For this reason, the main objective of the research in this article is to study the influence of the synchronous workstation supply method. On the performance of assembly lines. With the help of experience plans, the influence of certain input data (daily demand and diversity) considered at certain levels on the total cost was obtained. The values of these functions (response variables) that correspond to the factors and levels imposed by the experience plan, were obtained with the help of process simulation in the ARENA program. The analysis of the cost pointed out the fact synchronous supply methods have a significant influence on assembly lines performance.

Keywords: supply method, cost, assembly line, simulation.

INTRODUCTION

The supply of an assembly line represents the transport of the components needed for each product. The supply of an assembly line represents the transport of the necessary components to each workstation where products are assembled. Supply must consider two main actions: ensuring the required quantity according to demand but also ensuring all types of components (diversity) for all types of assembled products.

The synchronous supply method can only be applied if there are integrated production management systems. The information processed by these systems is used in synchronizing the supply flows with the production flow. Thus, the items needed for the product to be assembled arrive when they are needed. In this case, it is necessary to integrate a logistics preparation station (Figure 1) to ensure the synchronization of supply flows with the assembly line schedule.

There are two types of synchronous supplies: kitting and picking (sequencing).

Kitting is a synchronization method specific to small and medium sized items. A kit represents a specific set of components and/or sub-assemblies that, being present in the same container/ kit, serve one or more operations (workstations) in the assembly line for a given product.

Kit building is generally seen as non-added value work. However, there are researchers who believe that the formation of the kit represents an operation that brings added value to the finished product.

According to Bozer and McGinnis [2] there are two types of kits:

- stationary kits - remains at the workstation until the items that made it up have been assembled. The product to be assembled passes from one workstation to another
- traveling kits - move from one workstation to another together with the product to be assembled. In this case, the kit can serve several workstations until it is empty [4].

There are also two types of traveling kits. The first type consists of a kit in the form of a container, in which the product is also found. In the second type of kit, the product moves from one workstation to another in a container and is then followed by a container representing the kit [4].

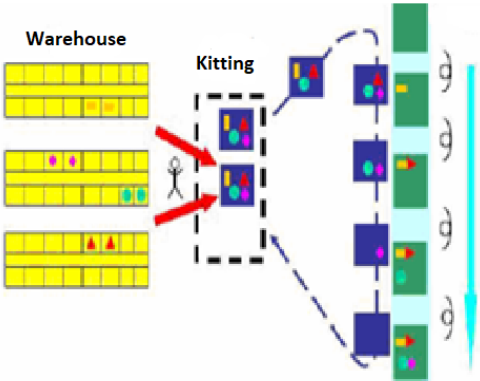

Fig. 1. Synchronous supply by a kitting area [3]

Picking (sequencing) is a method of synchronizing workstations supply specific to large items (Figure 4). The different types of an item are placed in a cart in the order in which they will be assembled in the assembly line (main line). By using picking, all the large packaging that was required in the inventory-based method of supply is eliminated, replaced by a single transport cart containing the required item types ordered according to the main flow. To justify the choice of picking, it is necessary that an article be of several types (at least a diversity of 2).

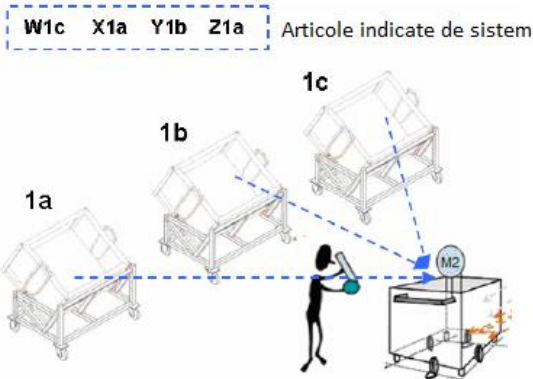

Figure. 2 Picking on a trolley

The operator designated with the internal logistics places the items in the cart so that the operator within the line can pick them up in the order of consumption. It can be LIFO or FIFO depending on the characteristics of the cart.

In the case of a synchronous supply, the totality of the processes must be particularly robust, including from the aspect of human organization. Human organization requires a particularly neat and detailed operating framework. But reactivity is also important when it comes to the proper functioning of the system. Therefore, is needed the implementation of a very precise framework and important autonomy.

This paper will analyze, using simulation with discrete events, how the synchronous supply method influences the performance of assembly lines.

DESCRIPTION OF THE STUDIED ASSEMBLY LINE

The models of the system were built according to the descriptions previously given and a few assumptions were made to simplify the simulation process, Fig. 3.

The most important assumptions were the following:

- the assembly line works 6 days a week, in 3 shifts of 8 hours each. There is a 30-minute break per shift for operator rest and meals.
- within the line, 4 types of products with the same composition are assembled.

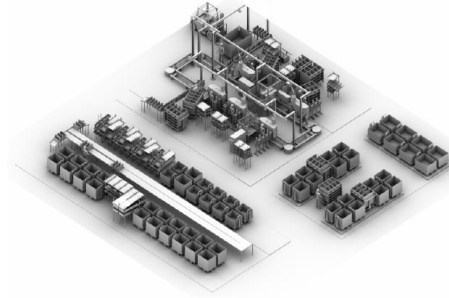

Fig. 3. The assembly line

- the composition of each product that can be made on the assembly line includes a number of 37 items, all located on the first level of decomposition of the product (all these items will be assembled directly on the product). The diversity of an article is given by the diversity of the products to be made: if there are 4 types of products to be assembled (engines) there are 4 types for each article $i \ R_{i,j}, i = \overline{1,37}; j = \overline{1,4}$;
- The technological processes for products M1-M4 include 5 assembly operations, one control operation and one unloading-packing operation (Table.1);

Table 1 Technological process for M1-M4 products

No. Operation (i)	Operation name	Workstation type	Cycle time (Without movement)
Op. 1	Assembly 1	Manual	0.797'
Op. 2	Assembly 2	Manual	0.668'
Op. 3	Assembly 3	Semi-automated	0.751'
Op. 4	Assembly 4	Manual	0.632'
Op. 5	Control	Automated	1.2'
Op. 6	Assembly 5	Manual	0.716'
Op. 7	Unloading/ packaging	Manual	0.66'

- the operations are carried out in the order imposed by the technological processes of the products.
- the line is served by 6 operators.
- the workstations that require maintenance are stations 3 and 5 since the other stations are entirely manual. The distribution laws for the maintenance intervention as well as the other characteristics are shown in Table 2.

Tabel.2 Maintenance data

Workstation	3	5
Distribution law	Weibull ($\beta = 1.35$)	Weibull ($\beta = 1.7$)
MTBF [ore]	787,1193	476,1029
MTTR (Tmi) [ore]	Norm (0,445;0,07)	Norm (0,533;0,07)

- the operator cost is 0,27 u.m./min
- each maintenance intervention on an equipment or machine costs 0,24 u.m./min

SIMULATION MODEL

To build an exact representation of the operating mode of the assembly line synchronous supply the simulation was made using logic modules.

The used modules are: order modules, process modules (assembly operations 1 – 7, kit making operation, picking (sequencing) operation, kitting and dollies transport), exit modules for finished products, kits and picking dollies.

The order modules have been built depending on the product diversity (Figure 6).

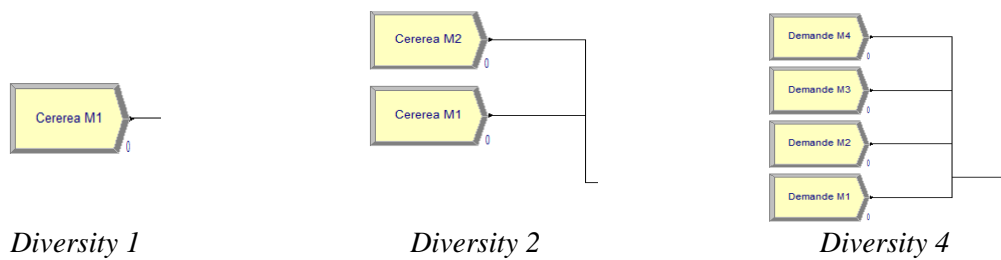

Figure 4. Order modules

Process modules (for each operation it was used a process module) used in the building of the assembly line – these modules simulate the assembly operations, kitting, picking and their transport (Figure 7 and 8).

For each operation it is designated a resource with the following characteristics:

- the cycle time of the operations, [min]
- the durations for the maintenance repairs, [hours]
- the cost for manufacturing, [u.m]

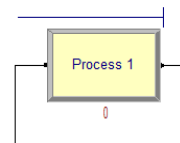

Figure 5. Process module

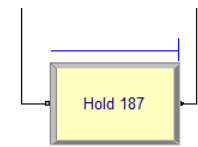

Figure 6. Hold module

Depending on the existing distance between the workstations it was determined the number of products on the conveyor between each 2 workstations (inter-process stock), Table 3.

Table 3 Inter-process stock level

PL _{i,i+1}	PL _{1,2}	PL _{2,3}	PL _{3,4}	PL _{4,5}	PL _{5,6}	PL _{6,7}
Stock	2	2	4	2	2	2

d) Kitting synchronization modules – is the module where the kits are made and transported to the assembly line, Figure 9.

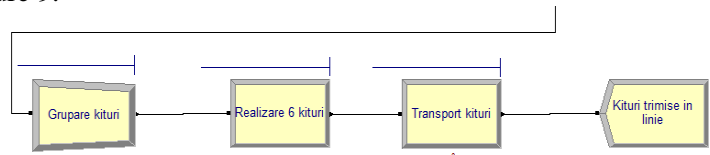

Figure 7. Kitting synchronization module

In this module another human resource (operator) must be integrated for the making of the kits if the demand or the diversity increases (Figure 10).

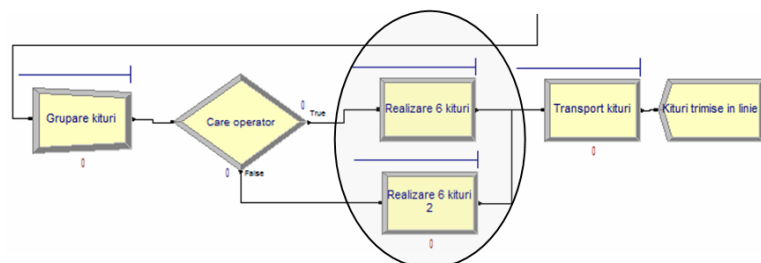

Figure 8. Operator surplus

If the diversity is 1 there are no picking platforms. Large items will be stored in the assembly line where they will ensure a certain autonomy. The transport of these items will be done by means of forklifts (Figure 11). Picking platform synchronization modules (diversity 2 and 4) are shown in Figure 12.

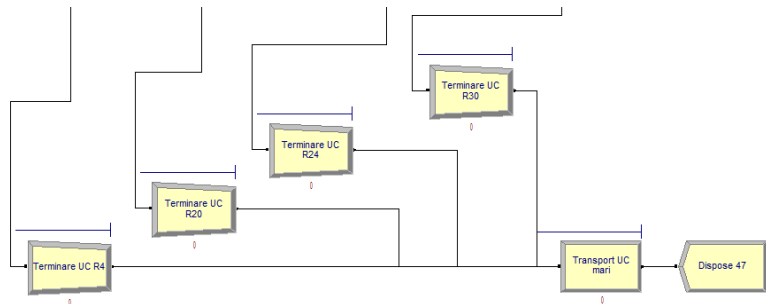

Figure 9. The transport module for the direct flow of packaging (diversity 1)

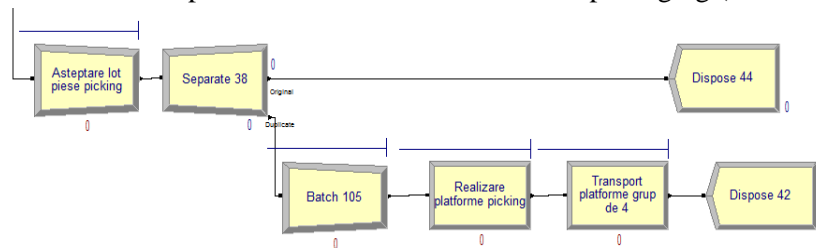

Figure 10.Synchronization modules for the picking dollies

With the help of these logical modules, the models for the synchronous supply method were successively built. The differences between the models exist at the level of three elements:

- demand - for each request from a certain type of product there is a Create module.
- making kits - depending on the result of a first simulation, we determined whether the number of operators making the kits is necessary. If this number is found to be insufficient, the model is modified by adding an operator.
- diversity – for diversity 1 there are conditioning units that are transported with forklifts within the assembly line

Thus, 5 simulated models of the assembly line with different configurations were made: diversity 1 – minimum demand, diversity 1 – maximum demand, diversity 2 – average demand, diversity 4 – minimum demand, diversity 4 – maximum demand.

VERIFICATION AND VALIDATION OF THE MODELS

Even if the experimentation on a real-life model (implementation on a production system) is not possible, all simulation models need to be checked and validated. In this article the checking and the validation of the models is made using the method developed by Naylor and Finger, [1]. This method implies the following steps:

- determine the warm-up (loading with articles) period of the system.
- determine the simulation period.
- model validation.

To determine the period of warm-up (loading) of the system, it was measured the productivity of the system, in a configuration that was the same in all models.

This configuration used to determine the warm-up period is:

- client demand of 353 products/day.
- diversity of 4 products.
- corrective maintenance in the workstations.

The model was run for a period of 69 hours of line operation and measurements were taken every 3 hours. Welch's method.

The graphic representation of the loading period is shown in Figure 13.

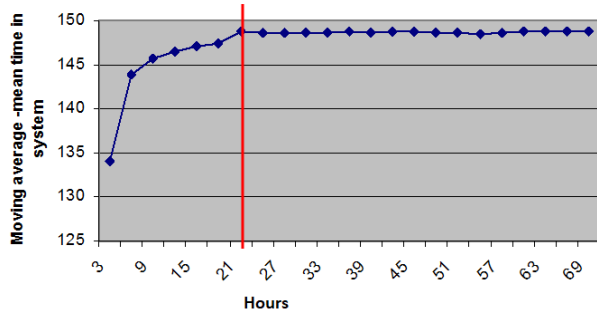

Figure 11 The loading period for the system

For all studied methods it was considered an article loading period of the system, W_p of 21 hours. The simulation duration is determined by multiplying the warm-up period of the system with 10, [1]. Table 3 contains the values of errors between the results of analytic calculus and the ones measured in as results of simulations.

Table 4. Error calculation

System productivity / Percentage difference	1 st conFIGuration	2 nd conFIGuration
<i>Theoretical</i>	9843	9345
<i>Synchronous supply model</i>	9719	9273
$\Delta\omega$ [%]	1.25	0.77

After using the method of Naylor and Finger to check and validate the 5 simulation models, the conclusions were the following:

- the period of loading with articles of the simulation models is of 21 hours.
- the simulation duration for the 5 models is of 210 hours.
- the simulated models give validated results that can be compared with a real-life situation.

SIMULATION RESULTS

The variable determined because of the simulation is the total cost. The total cost includes: the cost of making the kits, the cost of transporting the kits, the cost of making the picking dollies, the cost of transporting the picking dollies, the cost of using resources (idle time, busy time), the cost of waiting for the order in the assembly line. The components of the total cost considered for each situation are explained in Table 4.

Table 5. Total cost component values

	<i>Diversity 1</i>	<i>Diversity 2</i>	<i>Diversity 4</i>
Time to make 6 kits (min)	triang (10.8/11.4/12)	triang (11.4/12/12.6)	triang (12.6/13.2/13.8)
Time to make 4 picking dollies (min)	0	triang (6.4/ 6.8 /7.2)	triang (7.2/7.6/ 8)
Cost of resource busy, (u.m/h)	25		
Cost of resource idle (u.m/h)	20		
Cost of resource busy (u.m/h)	18.2		
Cost of resource idle (u.m/h)	16.2		
Transport time for 6 kits, Ttk (min)	triang (3.17/3.18/3.19)		
Transport time for 4 dollies, Ttp (min)	triang (14.9/14.91/14.92)		
Transport time for a small packaging (min), div 1	triang (3.71/ 3.72/ 3.73)		

We will consider the situations in which the total cost can be approximated by 4 function models: power (1), exponential (2), linear (3), linear logarithmic (4):

$$C_{total} = c \cdot D^a \cdot Div^b \quad (1)$$

$$C_{totale} = c \cdot a^D \cdot b^{Div} \quad (2)$$

$$C_{total} = a \cdot D + b \cdot Div + c \quad (3)$$

$$10^{C_{total}} = c \cdot D^a \cdot Div^b \quad (4)$$

To determine the cost functions, a two-level full factorial design with replications of experiences at the center of the variance is used. The total cost is dependent on the two input variables (D, Div). The chosen values for the input variables, expressed in natural, linearized and normalized values, are presented in Table 5.

Table 6. The values chosen for the input variables

Entry data	E_i	Mean values	$\lg E_i$ power and exponential model)	$\lg E_i$ (Linear and linear-logarithmic model)	Normative values
Daily demand	D_{min}	530	2.7242	2.7242	-1
	D_{medie}	750	2.875	2.9003	0
	D_{max}	1060	3.0253	3.0253	1
Diversity of products manufactured	Div_{min}	1	0	0	-1
	Div_{medie}	2	0.301	0.301	0
	Div_{max}	4	0.602	0.602	1

The values obtained for the total cost after each simulation of the operation of the synchronously supplied assembly line are shown in Table 6.

Table 7. Total cost values

Exp.	z_1	z_2	C_{total}	C_{total}
			Power and exponential model	Linear and linear-logarithmic model
1	-1	-1	1738488.24	1738488.24
2	-1	1	1991498.71	1991498.71
3	1	-1	2043726.15	2043726.15
4	1	1	2272191.28	2272191.28
5	0	0	1989300.29	1996619.61
6	0	0	1969975.21	1977294.53

To determine the cost functions, I used the Minitab software, version 16. In order to obtain the final form of the cost functions, the cost relationships were linearized, the experience plans related to each relationship were entered into Minitab, the regression analysis was performed, resulting in the regression lines from Figures 12-15.

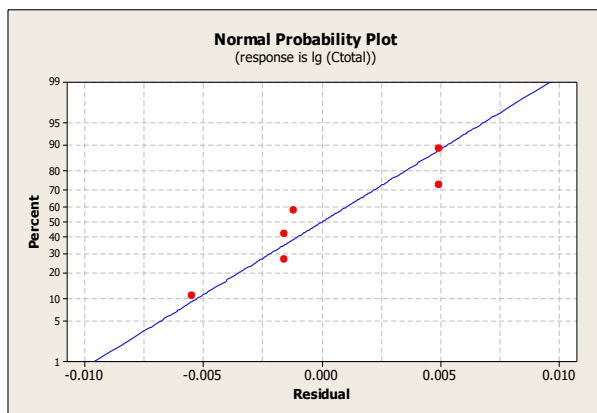

Figure12 The regression representation for the power model

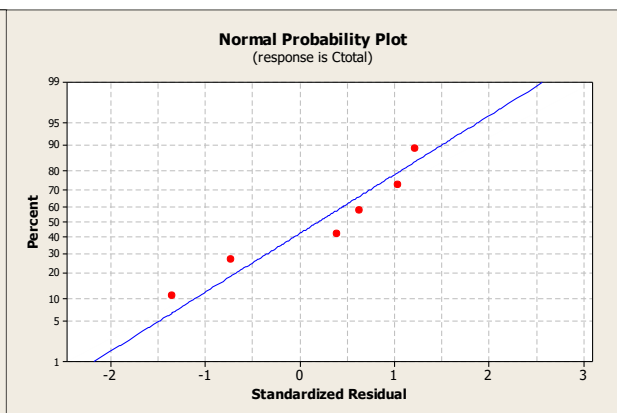

Figure 13 The regression representation for the linear-logarithmic model

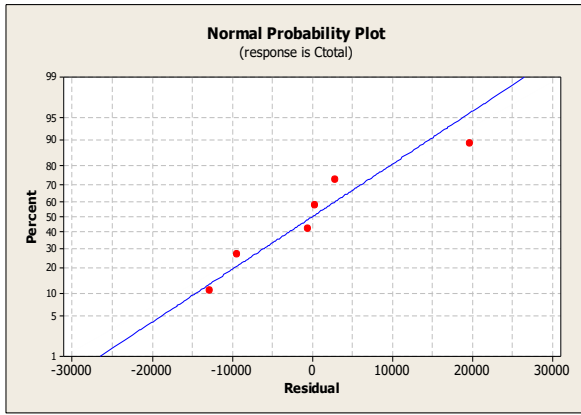

Figure 14 The regression representation for the linear model

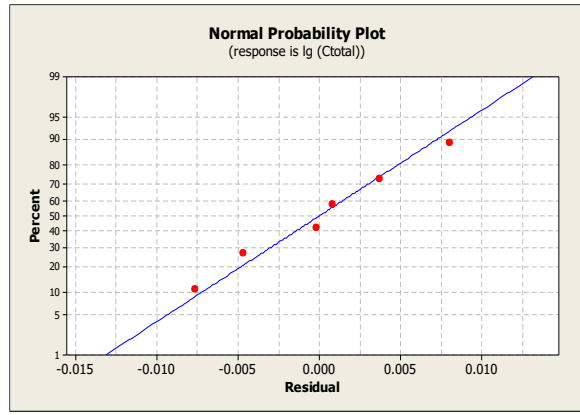

Figure 15 The regression representation for the exponential model

Transforming the linear form of the found function into the initial form of the cost, the final form of the relationship is obtained as follows:

$$C_{total} = 10^{5.66} \cdot D^{0.212} \cdot Div^{0.0872} \quad \text{power model}$$

$$10^{C_{total}} = 10^{-869445} \cdot D^{954605} \cdot Div^{399897} \quad \text{linear-logarithmic model}$$

$$C_{total} = 1379216 + 553 \cdot D + 79132 \cdot Div \quad \text{linear model}$$

$$C_{total} = 10^{6.17} \cdot 1.000271^D \cdot 1.0394^{Div} \quad \text{exponential model}$$

For a complete characterization of the chosen functions, it is also determined:

- the adequacy of the chosen model - can be checked by reading box A. For a suiTable model, the value of P in box A must be lower than 0.05.
- the significance of the coefficients of the function - can be read in box B. A coefficient is significant in the model if the value of P related to it is lower than 0.05.
- The total correlation coefficient between the output variable (C_{total}) and the input variables (D, Div) - shows that there are links between these two categories of variables. These links are stronger as the R coefficient approaches 1. Values of R can be found in the C range.

The regression equation is
 $C_{total} = -869445 + 954605 \lg D + 399897 \lg Div$

Predictor	Coef	SE Coef	T	P
Constant	-869445	328926	-2.64	0.077
lg D	954605	113820	8.39	0.004
lg Div	399897	57202	6.99	0.006

S = 34435.4 R-Sq = 97.5% R-Sq(adj) = 95.9%

PRESS = 14139707180 R-Sq(pred) = 90.24%

Analysis of Variance

Source	DF	SS	MS	F	P
Regression	2	1.41365E+11	70682395179	59.61	0.004
Residual Error	3	3557382309	1185794103		
Total	5	1.44922E+11			

Source	DF	Seq SS
lg D	1	83410005713
lg Div	1	57954784644

Obs	lg D	Ctotal	Fit	SE Fit	Residual	St Resid
1	2.72	1991499	1971826	28668	19673	1.03
2	3.03	2043726	2018520	27485	25206	1.22
3	2.90	1996620	2019563	14191	-22943	-0.73
4	3.03	2272191	2259258	27485	12933	0.62
5	2.90	1977295	2019563	14191	-42268	-1.35
6	2.72	1738488	1731088	28668	7400	0.39

Figure 16 Model characterization elements

Considering these statements, the characteristics of the models used in the total cost estimation are presented in Table 7.

Table 8. Characterization of the models used

Model	Model adequacy	Coef. relevancy	R (%)
$C_{total} = 10^{5.66} \cdot D^{0.212} \cdot Div^{0.0872}$	Adequate	All coefficients are relevant	98,8
$10^{C_{total}} = 10^{-869445} \cdot D^{954605} \cdot Div^{399897}$	Adequate	Irrelevant free coefficient	97,5
$C_{total} = 1379216 + 553 \cdot D + 79132 \cdot Div$	Adequate	All coefficients are relevant	99,6
$C_{total} = 10^{6.17} \cdot 1.000271^D \cdot 1.0394^{Div}$	Adequate	All coefficients are relevant	97,7

CONCLUSIONS

The linear model best approximates the behavior of the total cost function to variation in demand and diversity. It is found that as the input parameters increase, the total cost also increases. So, we could say that demand and diversity work in the same direction for the synchronous method. The influence of demand on the total cost is represented in Figure 17.

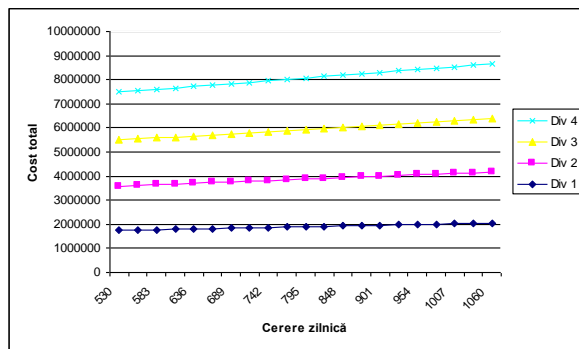

Figure 17 Influence of demand on total cost

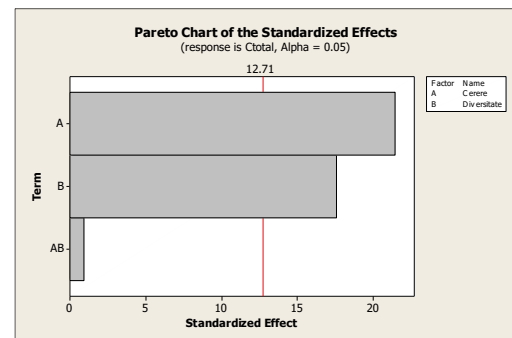

Figure 18
The influence of factors on the total cost

Regarding the influence of the factors, it is observed that the daily demand has a much greater impact on the total cost function (Fig. 17).

In Figure 20, the factors and interactions whose values exceed the critical threshold of 12.71 (t-Student distribution for one degree of freedom), correspond to elements that are significant for the chosen significance level ($\alpha=0.05$).

The studies within this article can be developed in the future by considering other input variables and using the technique of plans of experiences for all other considered supply methods to be able to determine the cost functions. By doing this, it will be possible to choose the supply method that generates the lowest costs

REFERENCES

- [1] Banks J., Carson II J. S., Nelson, B. L. (1999). Discrete-Event Simulation. Upper Saddle River,
- [2] Bozer, Y. A., & McGinnis, L. F. (1984). Kitting: A Generic Descriptive Model. Journal of Manufacturing and Operations Management, 4.
- [3] Caputo, A.C. and Pelagagge, P.M. (2010) A methodology for selecting assembly systems feeding policy. *Industrial Management & Data Systems*, Vol. 108 No. 6, pp. 726-49.
- [4] Oskar, C., Bjorn, H., (2007), "Kitting in a high variation assembly line", Lulea University of Technology.